

## DOORPHONES & VIDEO DOORPHONES

### DOORSTATIONS & CONTROL UNITS

series **400** *Comfort* individual type for 1-4 subscribers



#### **BVD-403A, (CPL)**

-20° right/left mounting base.  
50x150x38  
-40...+45°C (A)  
-30...+45°C (CPL)  
surface-mounted

**BVD-403A** Doorstation for 1 subscriber.

#### **BVD-403CPL** Video doorstation for 1 subscriber.

-Built-in colour camera with Day-Night feature  
(700 TVL, PAL, 0 Lux / IR LED ON, lens: PINHOLE 90°).  
-IR illumination for camera.



#### **BVD-405A-1, (A-2, A-4, CP-1, CP-2, CP-4)**

-20° right/left mounting base

**BVD-405A-1** Doorstation for 1 subscriber.

**BVD-405A-2** Doorstation for 2 subscribers.

**BVD-405A-4** Doorstation for 4 subscribers.

51x151x40  
-40...+45°C  
surface-mounted

**BVD-405CP-1** Video doorstation for 1 subscriber.

**BVD-405CP-2** Video doorstation for 2 subscribers.

**BVD-405CP-4** Video doorstation for 4 subscribers.

51x151x40  
-30...+45°C  
surface-mounted  
- Built-in colour camera with Day-Night feature  
(700 TVL, PAL, 0 - - Lux / IR LED ON, lens: PINHOLE 90°).  
- IR illumination for camera.

#### **BVD-406CB**

95x150x37  
-30...+45°C  
flush-mounted



#### **BVD-407RCB**

95x150x37  
-30...+45°C  
flush-mounted



#### **BVD-406CB**

Video doorstation for 1 subscriber.  
-Built-in colour camera with Day-Night feature (700 TVL, PAL, 0 Lux / -WHITE LED ON, lens: BOARD 120°).  
-Illumination for camera.

#### **BVD-407RCB**

Video doorstation for 1 subscriber.  
-Voice menu and service messages.  
-Built-in RFID reader (memory for 80 RF-keys).  
-Built-in colour camera with Day-Night feature (700 TVL, PAL, 0 Lux / WHITE LED ON, lens: BOARD 120°).  
-Illumination for camera.



#### **BVD-410CBL**

108x105x65  
-30...+45°C  
surface-mounted

**BVD-410CBL** Video doorstation for 1 subscriber.

- Built-in colour camera with Day-Night feature (700 TVL, PAL, 0 Lux / WHITE LED ON, lens: BOARD 120°).  
- Illumination for camera.  
- 20° right/left mounting base.

# DOORPHONES & VIDEO DOORPHONES

## DOORSTATIONS & CONTROL UNITS

series 400 *Comfort* multi-apartment type for up to 40 subscribers

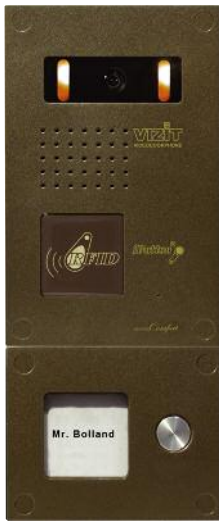

**BS-1**  
95x75x9.5  
-30...+45°C  
surface-mounted



**BVD-408RCB-40**  
95x150x39  
-30...+45°C  
flush-mounted

**BS-2**  
95x75x9.5  
-30...+45°C  
surface-mounted

**BVD-408RCB-40**  
-Video doorstation for up to 40 subscribers to operate with button stations BS-1, BS-2, BS-4, BS-8 and control unit BUD-408M.  
-Built-in RFID reader.  
-Built-in colour camera with Day-Night feature (700 TVL, PAL, 0 Lux / WHITE LED ON, lens: BOARD 120°).  
-Illumination for camera.

**BS-1, BS-2, BS-4, BS-8**  
Button station for 1, (2, 4, 8) subscribers to operate with BVD-408RCB-40 & BUD-408M. Backlit name labels.



**BS-4**  
95x150x9.5  
-30...+45°C  
surface-mounted

**BUD-408M**  
Control unit to operate with BVD-408RCB-40 & BS-1, BS-2, BS-4, BS-8.  
- Power supply function.  
- Operating voltage 230 VAC.  
- Up to 40 subscribers.  
- RFID controller function (memory for 1,200 RF keys).  
- Voice menu and service messages.  
- Team-work of 2 BUD-408M.  
- Power supply for door lock, lock control function.



**BS-8**  
95x150x9.5  
-30...+45°C  
surface-mounted

**BUD-408M**  
188x114x62  
230±23VAC  
+1...+40°C



## CONFIGURATIONS

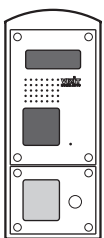

BVD-408  
BS-1  
MK-408-1

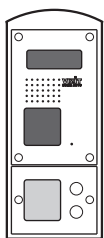

BVD-408  
BS-1  
MK-408-1

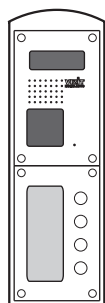

BVD-408  
BS-1  
MK-408-4-1

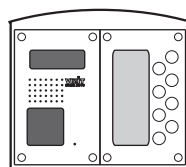

BVD-408  
BS-1  
MK-408-4-2

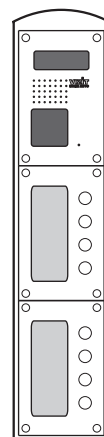

BVD-408  
BS-1  
MK-408-8

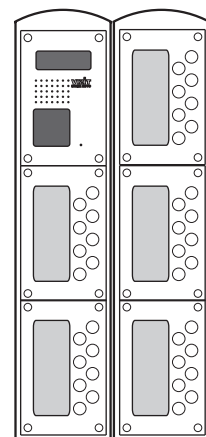

BVD-408  
BS-1  
MK-408-8x2

# DOORPHONES & VIDEO DOORPHONES

## DOORSTATIONS & CONTROL UNITS

series **300** multi-apartment type for up 200 subscribers



### **BVD-313R, (RCP)**

90x180x22  
-30...+45°C  
surface-mounted

**BVD-313R** Doorstation to operate with control unit BUD-302x.

- Built-in RFID reader.
- Lit keypad.

**BVD-313RCP** Video doorstation to operate with control unit BUD-302x.

- Built-in RFID reader.
- Lit keypad. Built-in colour camera with Day-Night feature (700 TVL, PAL, 0.5 Lux, lens: PINHOLE 90°).

### **BVD-342R**

87x171x24  
-40...+45°C  
surface-mounted



**BVD-342R** Doorstation to operate with control unit BUD-302x.

- Built-in RFID reader.
- Lit keypad.
- 4-digit LED indicator

**BVD-343R** Doorstation to operate with control unit BUD-302x.

- Built-in RFID reader.
- Lit keypad.
- 4-digit LED indicator.

**BVD-343RCP** Video doorstation to operate with control unit BUD-302x.

- Built-in RFID reader.
- 4-digit LED indicator. Lit keypad.
- Built-in colour camera with Day-Night feature (700 TVL, PAL, 0 Lux / IR LED ON, lens: PINHOLE 90°).
- IR illumination for camera.

### **BVD-343R, (RCPL)**

87x171x27  
-40...+45°C (R)  
-30...+45°C (RCPL)  
surface-mounted



### **BUD-302K-20, BUD-302M**

188x114x62  
230±23VAC  
+1...+40°C



**BUD-302K-20** Control unit for VIZIT doorphone / video doorphone of Series 300.

- Power supply function.
- Operating voltage 230 VAC.
- Up to 20 subscribers. Integrated commutator for 20 apartment handsets.
- Keypad code & RFID controller function (memory for 20 individual access codes & 600 RF keys).
- Power supply for door lock, lock control function.

**BUD-302M** Control unit for VIZIT doorphone / video doorphone of Series 300.

- Power supply function.
- Operating voltage 230 VAC.
- Up to 200 subscribers.
- Keypad code & RFID controller function (memory for 200 individual access codes & 2,400 RF keys).
- Power supply for door lock, lock control function.

## DOORPHONES & VIDEO DOORPHONES

### DOORSTATIONS & CONTROL UNITS

series 400 *Comfort* multi-apartment type for up 200 subscribers



#### **BVD-432RCB**

190x150x38

-30...+45°C

flush-mounted

Video doorstation to operate with control unit BUD-420M.

- Built-in RFID reader, LCD, concierge CALL button.
- Built-in colour camera with Day-Night feature (700 TVL, PAL, 0 Lux / WHITE LED ON, lens: BOARD 120°).
- Illumination for camera.



#### **BUD-420M**

188x114x62

230±23VAC

+1...+40°C

Control unit for VIZIT doorphone / video doorphone of Series 400.

- Power supply function.
- Operating voltage 230 VAC.
- Up to 200 subscribers.
- Keypad code, TOUCH MEMORY & RFID controller function (200 individual access codes, 1,200 RF / TM keys).
- Power supply for door lock, lock control function.
- Support of doorstation LCD.
- Team-work of 4 BUD-420M.

## DOORPHONES & VIDEO DOORPHONES

### OUTDOOR CAMERA

#### **BVD-403CPO**



**BVD-403CPO** Vandal-proof colour camera with Day-Night feature (700 TVL, PAL, 0 Lux / IR LED ON, lens: PINHOLE 90°).

- Built-in door bell button.
- IR illumination for camera.
- 20° right/left mounting base.

#### **AP-143G**



**AP-143G** Vandal-proof Day-Night camera in hermetic case (colour, PAL, 420 TVL, 0 Lux / IR LED ON, lens: BOARD 92°).

- Light sensor. 24 LEDs
- illumination range = 20m.

## DOORPHONES & VIDEO DOORPHONES

### COMMUTATION DEVICES & DISTRIBUTION AMPLIFIER

#### **BK-2V; BK-4M; BK-4MV; BK-10; BK-30M; BK-100M; RVS-2; RVS-4**

**BK-2V** Video switcher to connect 2 video doorstations of Series 400 to single video line.

Commutator to connect up to 4 (**BK-4M**), 10 (**BK-10**) apartment handsets to intercom line.

**BK-4MV** Commutator with integrated distribution amplifier to connect up to 4 video monitors of Series 400 to video & intercom line .

**BK-30M** Commutator to connect up to 30 apartment handsets to intercom line.

**BK-100M** Commutator to connect up to 100 apartment handsets to intercom line.

**RVS-2** Distribution amplifier to connect 2 video monitors (VIZIT-MT456C, VIZIT-M430C, VIZIT-M440C) to group power supply unit BPD24/12-1-1, to main video line and storey video line from outdoor camera. Power supply for storey camera via video monitors.

**RVS-4** Distribution amplifier to connect up to 4 video monitors of Series 400 to video & power supply lines.



## DOORPHONES & VIDEO DOORPHONES

### CONCIERGE CONSOLE FOR MULTI-APARTMENT DOORPHONES & VIDEO DOORPHONES

#### VIZIT-TK401DN



#### VIZIT-TK401DN

Concierge terminal to operate with control unit VIZIT-TU412 as concierge console VIZIT-PK200.

#### VIZIT-TU412M1

Control unit for concierge console VIZIT-PK200. Up to 199 subscribers (+ concierge).  
- Operating voltage 230 VAC.

#### VIZIT-TU412M1

188x114x62  
230±23VAC  
+1...+40°C



## DOORPHONES & VIDEO DOORPHONES

### APARTMENT HANDSETS

#### UKP-7



#### UKP-12



#### UKP-12M



#### UKP-12-1



**UKP-7** Apartment handset with ring volume slide switch. Colour: white.

**UKP-12** Apartment handset with ring volume slide switch and call indicator. Colour: white.

**UKP-12M** Apartment handset with ring volume slide switch and call indicator. Colour: silver handset, grey holder.

**UKP-12-1** Apartment handset with option to connect additional handset. Call indicator, ring volume slide switch. Colour: white.

## DOORPHONES & VIDEO DOORPHONES

### MONITORS FOR VIDEO DOORPHONES

#### VIZIT-M440C



#### VIZIT-M440CM



#### VIZIT-M456C



#### VIZIT-MT460CM



**VIZIT-M440C** Video monitor (colour, PAL, 3.5" TFT LCD).  
- Option to operate with 2 doorstations via BKM-440.  
- Option to connect outdoor camera and door bell button.

**VIZIT-M440CM** Video monitor (colour, PAL, 3.5" TFT LCD).  
- Non-volatile memory (64 b/w images).  
- Option to operate with 2 doorstations via BKM-440.  
- Option to connect outdoor camera and door bell button.  
- 4 ring tones.

**VIZIT-M456C** Video monitor (colour, PAL, 5.6" TFT LCD).  
- Option to operate with 2 doorstations via BKM-440.  
- Option to connect outdoor camera and door bell button.  
- 5 ring tones.

**VIZIT-MT460CM** Monitor's terminal (colour, PAL, 5.6" TFT LCD) to operate with BKM-440.  
- Non-volatile memory (32 b/w images).  
- 5 polyphonic ring tones.  
- English/Russian on-screen menu.

## DOORPHONES & VIDEO DOORPHONES



**BKM-440**  
188x114x62  
230±23VAC  
+1...+40°C

- 2-channel commutator & power supply unit to operate with VIZIT-MT460CM, VIZIT-M456C, VIZIT-M430C.  
- Operating voltage 230 VAC

## ACCESS CONTROL SYSTEMS

**VIZIT-KTM600R**



**VIZIT-KTM602R**



**VIZIT-KTM600R**  
47x75x25 (reader);  
75x135x35 (control unit);  
-40°C to +50°C (reader)  
+1°C to +40°C (control unit).

**VIZIT-KTM602R**  
47x75x25 (reader);  
165x90x60 (control unit);  
-40°C to +50°C (reader)  
+1°C to +40°C (control unit).

RF controller  
- Memory for 2680 RF keys.  
- Lock control, timer for 1 / 5 sec.  
- Operating voltage 12...24 VDC;

RF controller  
- Memory for 2680 RF keys.  
- Lock control & power supply, timer for 1 / 5 sec.  
- Operating voltage 230 VAC.  
- 18V/0.4A output to supply power to 1-subscriber doorphone / video doorphone.

## ELECTRONIC IDENTIFIERS

**VIZIT-RF2.1**



**VIZIT-RF2.2**



**RF key** (RFID fob, 125 kHz)

**VIZIT-RF2.1** Plastic fob, embossed logo.  
- Colour: gray;

**VIZIT-RF2.2** Leather fob, embossed logo.  
- Colour: black

## POWER SUPPLY UNITS

**BPD18/12-1-1, 19w/14.4v/EU(12V/1.5A),**  
**BPD24/12-1-1 19w/14.4v/EU(18V/1A)**  
165x90x60;  
230±23VAC  
+1...+40°C



**Unregulated power supply unit**

**BPD18/12-1-1** Input voltage 230±23VAC, output voltage 18V/0.7A, 12V/0.6A. Plastic case. To feed VIZIT doorphone including door lock;

**Regulated power supply units**

**BPD24/12-1-1** Input voltage 230±23VAC, output voltage 24V/0.8A, 12V/0.3A. Plastic case. Group power supply for video monitors (24V). To feed outdoor camera (12V).

**19w/14.4v/EU(12V/1.5A)** Input voltage 100..240VAC, output voltage 12V/1.5A. Plastic case. To feed outdoor camera.

**19w/14.4v/EU(18V/1A)** Input voltage 100..240VAC, output voltage 18V/1.0A. Plastic case. To feed video monitor VIZIT-M430C / VIZIT-M440CM / VIZIT-M456C with doorstation and extra outdoor camera.

## ELECTROMAGNETIC LOCKS

**VIZIT-ML240-40,**  
**VIZIT-ML300M-40,**  
**VIZIT-ML400-40**



**Button "EXIT 300M"**



**VIZIT-ML240-40** Electromagnetic lock (12VDC, 0.6A, 240kg holding force). Built-in degaussing module.

**VIZIT-ML300M-40** Electromagnetic lock (12VDC, 0.6A, 300kg holding force). Built-in degaussing module.

**VIZIT-ML400-40** Electromagnetic lock (12VDC, 0.6A, 400kg holding force). Built-in degaussing module.

- Fastening kit with 40x40mm mounting angle bar. (**VIZIT-ML240-40, VIZIT-ML300M-40, VIZIT-ML400-40**);

**EXIT 300M** Button to release electromagnetic lock. 300,000 operation cycles.

- LED ring illumination.

## MOUNTING KITS & ACCESSORIES

**MK-311**

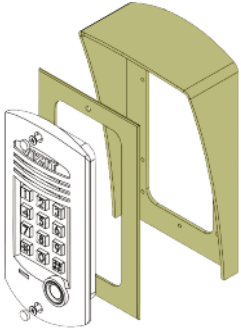

**MK-405**

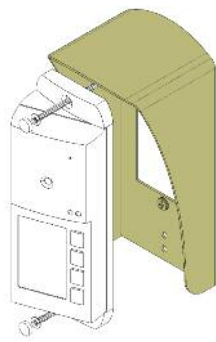

**MK-406**

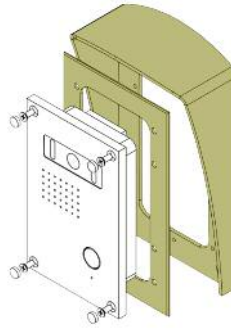

**MK-311** Mounting kit to protect doorstation BVD-311, BVD-313, BVD-342, BVD-343 against sun, rain & snow (sun/rain shield – 1 pc., mounting plate – 1 pc., fasteners);

**MK-405** Mounting kit to protect doorstation BVD-403, BVD-405 against sun, rain & snow (sun/rain shield – 1 pc., fasteners).

**MK-406** Mounting kit to protect doorstation BVD-406, BVD-407, BVD-408 & button stations BS-1, BS-2, BS-4, BS-8 against sun, rain & snow (sun/rain shield – 1 pc., mounting plate – 1 pc., fasteners);

**MK-408-1**

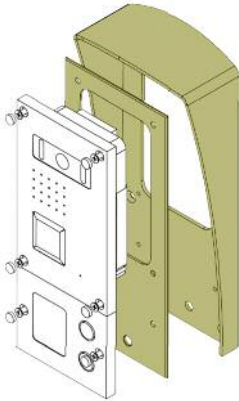

**MK-408-4-1**

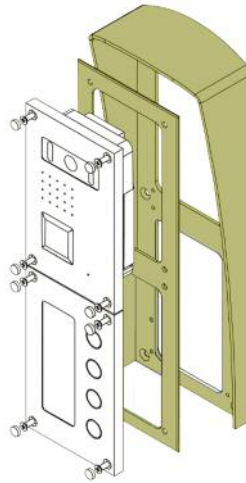

**MK-408-1** Mounting kit to protect doorstation BVD-408 with button station BS-1 / BS-2 against sun, rain & snow (sun/rain shield – 1 pc., mounting plate – 1 pc., fasteners);

**MK-408-4-1, MK-408-4-2** Mounting kit to protect doorstation BVD-408 with button station BS-4 / BS-8 against sun, rain & snow (sun/rain shield – 1 pc., mounting plate – 1 pc., fasteners);

**MK-408-8** Mounting kit to protect BVD-408 with button stations BS-4 / BS-8 against sun, rain & snow (sun/rain shield – 1 pc., mounting plate – 1 pc., fasteners);

**MK-408-4-2**

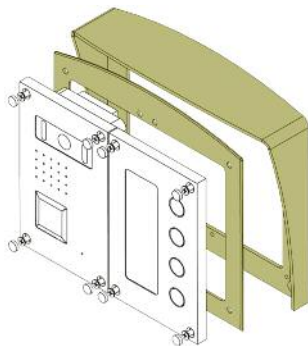

**MK-408-8**

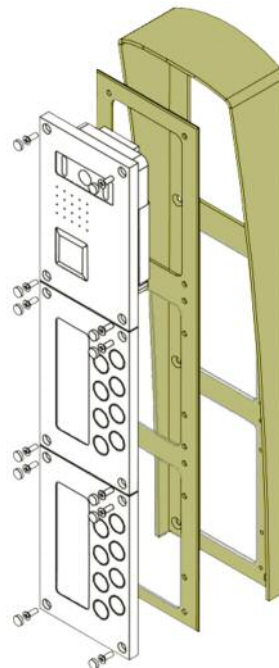

**MK-432** Mounting kit to protect doorstation BVD-431, BVD-432 against sun, rain & snow (sun/rain shield – 1 pc., mounting plate – 1 pc., fasteners);

**MK-432**

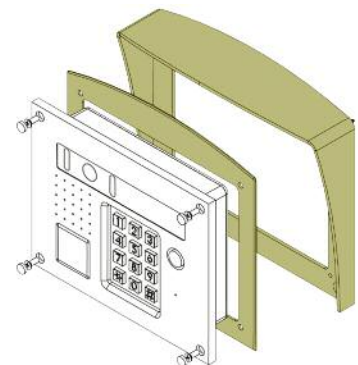

## MOUNTING KITS & ACCESSORIES

### MK-N10-BA



### MK-N10-BL



### MK-N10-BO



### MK-N10-PL



**MK-N10-BA** A set of gags (4 pcs.) for installation of door units VIZIT. Colour: BRONZE ANTIQUE

**MK-N10-BL** A set of gags (4 pcs.) for installation of door units VIZIT. Colour: BRONZE LACQUER

**MK-N10-BO** A set of gags (4 pcs.) for installation of door units VIZIT. Colour: BRONZE OLD

**MK-N10-PL** A set of gags (4 pcs.) for installation of door units VIZIT. Colour: PLATINUM LACQUER



**BVD-342NP**  
86x171x210  
-40...+45°C  
surface-mounted

**BVD-342NP** Name plate to operate with doorstation BVD-342, BVD-343. Backlit name labels.



**RD-3**  
47x75x25  
-40°C to +50°C  
surface-mounted

**RD-3** VIZIT-RF keys reader for RF controllers VIZIT-KTM600R, VIZIT-KTM602R; surface mounting; sound indication of operating modes, LED indicator. Colour: PLATINUM LACQUER. NEW.



**VIZIT-MB1P**  
251x336x93  
230±23VAC  
+1...+40°C

**VIZIT-MB1P** Mounting box to house commutator, power supply or control unit. NEW (quarter 2, 2013).



**VIZIT-MB2P**  
251x208x93  
230±23VAC  
+1...+40°C

**VIZIT-MB2P** Mounting box to house commutator, power supply or control unit. NEW (quarter 2, 2013).

All products listed in this pricelist proved  compliant.